

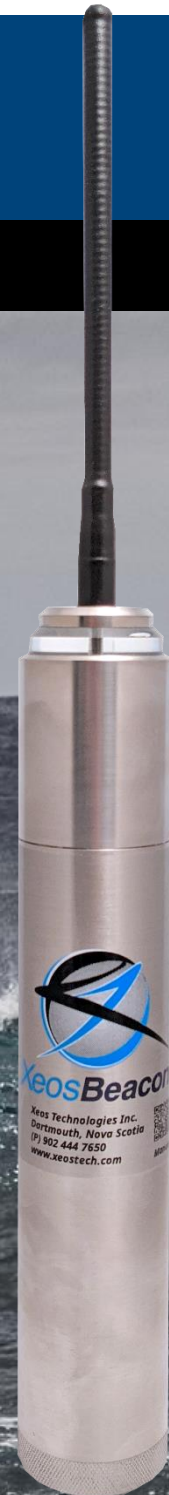

Xeos
Technologies Inc.

Petrel User Manual

Submersible AIS-Compatible Beacon



Version 1.0

April 2023

Shipped From

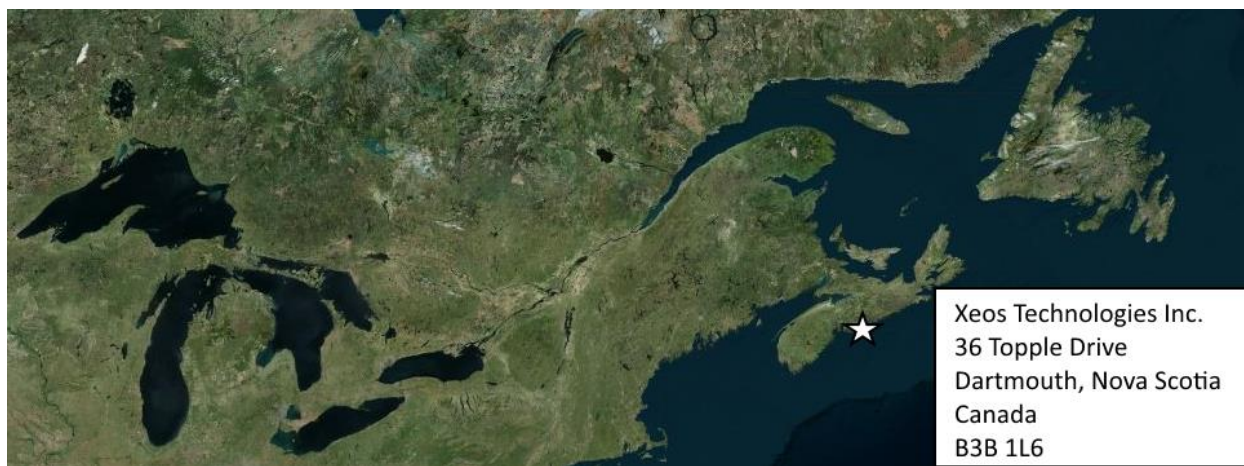

Contact Us

Email support@xeostech.com
Phone +1 (902) 444-7650
Fax +1 (902) 444-7651
Website www.xeostech.com

Version History

Version No.	Date	Description
1.0	Apr 2023	Initial release

Regular checks for the latest manual are suggested. Be sure to check [Xeos Technologies' manuals page](#) to compare versions and download the latest version.

Table of Contents

Preliminary Setup.....	4
Outside Diagram.....	4
Physical Connection (Remote Head).....	4
Petrel Operation	5
Installation.....	5
Operational Tips	5
State Diagram.....	5
Petrel Operating Modes.....	6
Powering the Device	6
Using the Magnet Switch.....	6
Water Sensing.....	10
Bluetooth	10
Commands	11
Settings and Defaults	12
Maintenance	13
Battery Pack	13
O-Rings	14
Electrical Specifications.....	15
Maintenance Specifications.....	15
Connector Pinout	16
Petrel Remote Head	16
Battery Pack	16
Mechanical Drawing	17
Warranty, Support and Limited Liability.....	18

Preliminary Setup

Outside Diagram

The Petrel has several items of note to help identify a specific device. Shown below are those identifiers along with key sections.



1	The AIS antenna is screwed into the top of the Petrel and must be installed before operation
2	The on/off LED of the Petrel is located here. The titanium sections above and below the glass must be shorted to trigger the water sense
3	The magnet switch for turning the Petrel on and off is located directly below the glass
4	The meeting point of the electronics head and battery chamber is torqued and should not be opened. A sealing O-ring is installed here.
5	The factory serial number of the Petrel is on the label.
6	A QR code is available to scan to download the manual on the label
7	The bottom endcap is hand-tight for battery replacement. A sealing O-ring is installed here.

Physical Connection (Remote Head)

Pin Number	Name
1	N/C
2	N/C
3	N/C
4	+V Battery
5	N/C
6	Ground

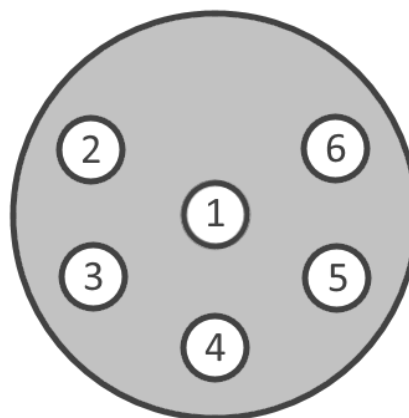

Connector: MCBH-6F-TI, External View

Petrel Operation

Installation

When installing the Petrel there are several factors that can influence performance.

- The Petrel’s head must be pointing directly upward as much as possible.
- GNSS and AIS performance may suffer if large angles of the horizon are blocked, such as if the Petrel is next to a wall.
- Do not use conductive material at the top of the Petrel around the glass lens; this will cause the water sensor to fail.

Operational Tips

- Connecting power, or power cycling the device will cause the device to restart from the beginning of its operational cycle.
- The beacon requires a good view of the sky for any test. It is necessary that any tests be done outside of a building, far from potential obstructions.

State Diagram

Below is a diagram of the various transitions in the Petrel.

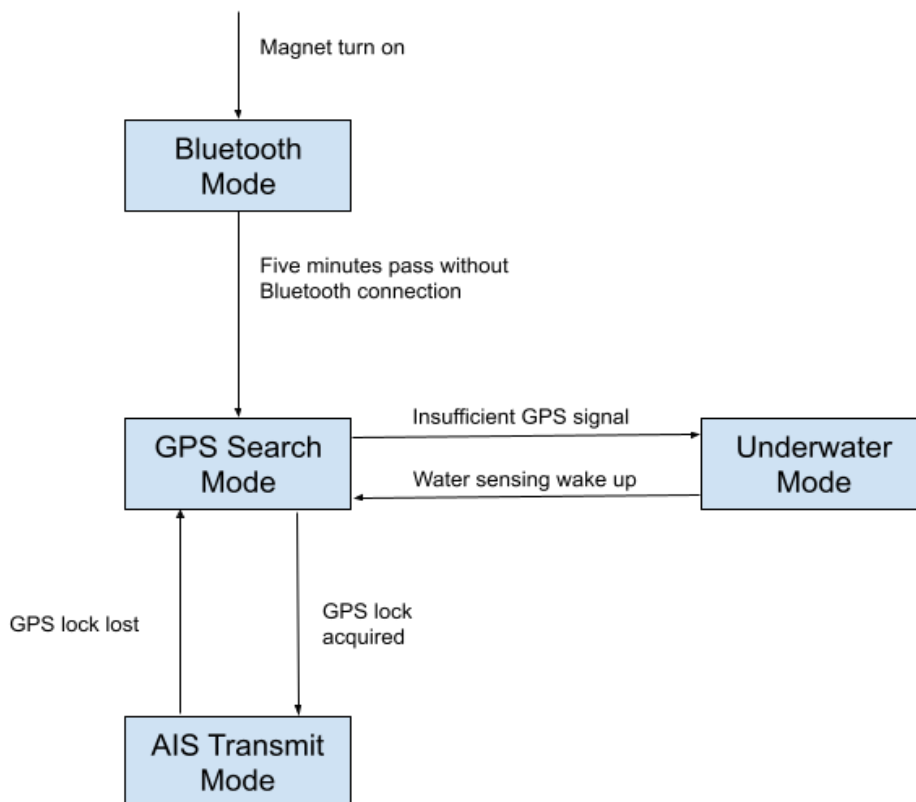

Petrel Operating Modes

Powering the Device

The Petrel will turn ON as soon as power is given to the device. Due to this, starting or resetting the device can be achieved by adding batteries and closing the bottom endcap.

In situations where the device is closed and the desired state is OFF (for example, during transit) the magnetic switch can be used.

Using the Magnet Switch

The Petrel can be turned ON and OFF using an external magnet near an internal magnetic switch, located just below the glass. The Petrel will flash an LED to indicate its ON/OFF state after 1-2 magnet swipes near the switch. A **green** LED flash means the unit is ON, a **red** LED flash means the unit is OFF.

To change the Petrel to the opposite ON/OFF state, swipe the magnet repeatedly until the LED color changes to that of the desired state.

For example, if the unit is currently ON and needs to be turned OFF, swipe the magnet repeatedly until the LED changes from green (ON) to red (OFF). Once the red LED is seen, the device will transition to the off state.

Unit Status Indicators	
Action: Turn On	Swipe magnet across switch until LED is solid green
Action: Turn Off	Swipe magnet across switch until LED is solid red

The Petrel can be turned on or off using the magnet turn-off method any time, regardless of its current state.

Bluetooth Mode

Bluetooth Mode is the initial state of the Petrel after a reset or power-up. In this mode, Bluetooth is active and can be connected to with the [Xeos Beacon Bluetooth App](#).

If no Bluetooth connection is made in 5 minutes, the unit will proceed to GPS Search Mode. However, if a Bluetooth connection is established, the unit will stay in Bluetooth mode until 5 minutes after the most recent Bluetooth session has ended.

If the Petrel unit has exited Bluetooth mode before a Bluetooth connection could be made, the magnet can be used to reset the unit, to re-enter Bluetooth mode.

While in Bluetooth mode, both the AIS and GPS functionality of the unit are inactive. The unit will not attempt to acquire a GPS lock and will not transmit or receive AIS messages.

GPS Search Mode

In GPS Search Mode, the Petrel unit will attempt to acquire a GPS lock. While in this mode, the unit's Bluetooth and AIS functionality are inactive.

If the attempt to acquire a GPS lock is successful, the unit will proceed to AIS Transmit Mode. If the attempt fails, the unit will proceed to Underwater Mode. The decision to proceed to these states is made according to the following decision criteria:

- If a GPS lock is obtained, the unit will progress automatically to AIS Transmit Mode.
- If any 5 minute period passes without the unit observing a single GPS satellite above a minimum threshold for signal integrity, the unit proceeds to Underwater Mode.
- If 14 minutes pass without a GPS lock being obtained, the unit proceeds to Underwater Mode. Note that this 14 minute timeout can be adjusted to be longer or shorter (GPS Timeout).

AIS Transmit Mode

In AIS Transmit Mode, the Petrel will maintain its GPS lock and activate its AIS functionality to transmit and receive AIS messages. While in this mode, the unit's Bluetooth functionality is inactive.

The Petrel will continuously receive AIS messages and interpret them in order to build an internal AIS slot map. This slot map is used to avoid slot collisions with other AIS devices when the Petrel chooses to transmit.

The Petrel will wait at least 1 minute before transmitting to ensure it has fully mapped which AIS slots are in use. Once this process is complete, it will use its slot map and slot selection algorithm to find two consecutive free slots. Two slots are required because the Petrel transmits AIS message type 21, which fills two AIS slots. If at any time the unit is not able to find two consecutive slots, it will wait for one minute and try again.

A Petrel's AIS transmissions contain an MMSI and an AIS name.

- The AIS name is made of up to 20 characters, which can be a combination of uppercase letters (A-Z) or numbers (0-9). The AIS name can be set by the user.
- The MMSI is set during the assembly phase and cannot be changed by the user.

A Petrel's first transmission will always be on AIS channel B. It will then proceed to alternate between channels A and B for successive transmissions.

The Petrel's AIS system performs various integrity checks at different times to ensure it is transmitting AIS messages appropriately. If any of these integrity checks fail, the Petrel will perform a complete reset of its internal AIS system. This may cause the unit's transmission period to deviate from the usual 3 minutes, and cause it to perform consecutive channel B transmissions.

Underwater Mode

While in Underwater Mode, the Petrel will turn off all non-essential functionality and put itself into a sleep state to minimize power consumption. At regular intervals (every 5 minutes by default), the Petrel unit will perform a water sense check to determine if it is above water or submerged. If the check indicates that the unit is above water, it will exit Underwater Mode and return to GPS Search Mode.

Due to environmental concerns such as biofouling, it is possible for the water sense check to result in false positives. To combat this problem, the Petrel has a backup counter that automatically returns the unit to GPS Search Mode when it expires. In the event the unit surfaces, but cannot sense the lack of water due to biofouling, the unit will still progress to GPS Search Mode when the backup timer expires. The duration of this timer is user-adjustable by changing the GPS Timeout setting.

If the backup counter expires while the unit is still underwater, it will transition to GPS Search Mode while underwater. In this situation, the unit will not be able to receive messages from any GPS satellites at sufficient signal integrity. It will therefore return to Underwater Mode in approximately 5 minutes to avoid spending excessive power on GPS searches while underwater.

Water Sensing

The Petrel's water sensor is used to detect whether it is above water or submerged. The sensor measures the resistance between the antenna and the electronics head. When the Petrel is above water, the water sensor is not used. The water sensor will only begin measuring once the unit enters underwater mode in an effort to detect surfacing events.

The Petrel's water sense determination is programmatically set to operate optimally in salt water environments. To operate the device in freshwater, the water sense threshold value may need to be increased to trigger a water sense surfacing event.

The water sense reading has to be **lower** than the threshold number when submerged, and higher than the threshold number when surfaced for surfacing to take place. Freshwater environments can vary in the reading given. Therefore, testing should be done ahead of freshwater deployments to ensure proper operation.

Bluetooth

The Petrel has integrated Bluetooth hardware to facilitate local communication with the user for configuration and firmware upgrades via the [Xeos Beacon Bluetooth App](#).

The Petrel's Bluetooth will advertise while in Bluetooth mode, after boot. When a Bluetooth connection is established, the unit will flash its green LED several times.

Bluetooth mode normally lasts for 5 minutes after the unit is turned on. If a Bluetooth connection is established, the unit will not exit Bluetooth mode until 5 minutes have passed since the last Bluetooth session ended.

Commands

Below are commands for the Petrel. At this time, commands can only be sent over Bluetooth.

- Each command starts with a dollar sign (\$). The Bluetooth app prepends this automatically.
- If a parameter is possible (marked with an X below), that parameter can be an integer to change the setting, or a question mark (?) to query the current settings. Please refer to the [Settings and Defaults](#) section below for limits and defaults.

Command	Description
aisname	Get the ais name that the unit will use in its AIS messages.
setaisname [name]	Set the ais name that the unit will use in its AIS messages. Maximum 20 characters, using uppercase letters (A-Z) or numbers (0-9).
mmsi	Get the MMSI number that the unit will use in its AIS messages.
gpstimeout X	Duration GPS runs before shutting off, in seconds.
wsthresh X	The water/underwater threshold.
wsr	Perform a water sense check (This command is for testing purposes and does not cause the unit to change states.)
wsperiod X	The rate of water sense checks while in the underwater mode. Sent as an integer representing the number of seconds in between water checks.
wsbackper X	The period of backup water checks. Example: If this is set to 5, every fifth water check will consist of a backup water check.
sn	Show the unit's production serial number.
rv	Query the unit's supply voltage. Result is measured in volts.
sysinfo	The unit will display system information.
underwater	The unit will immediately transition to underwater mode.
resetnow	The unit will reset itself. No settings will be changed.
skipbt	The unit will disconnect from any Bluetooth connection, exit Bluetooth mode and proceed directly to GPS Search mode.
hdw	Show the unit's hardware revision.
ver	Show the unit's current firmware version.

Settings and Defaults

Setting	Default	Min	Max	Description
GPS Timeout	840s	300s	3600s	Length the Petrel will be in GPS Search Mode before timing out and transitioning to Underwater Mode.
Water Sense Threshold	150	0	5,000	The numerical boundary between submerged and surfaced.
Water Sense Period	300s	60s	1800s	The rate at which the water sense measurement is taken.
Water Sense Backup Period	288 (1 ck/day)	0	20,000	How often, per every X water sense checks, a secondary check is taken.
AIS Name	Up to 20 characters, which can be uppercase letters or numbers			The name of the Petrel when it transmits over AIS

Maintenance

Battery Pack

The power source for the Petrel is its battery pack. There are two battery pack sizes for the Petrel:

Long Pack	7 Energizer LR20 D-Cell Alkaline	10.5V
Short Pack	3 Saft LSH20 D-Cell Lithium	10.8V

For Lithium models, only the Saft LSH20 has the ability to source enough current to supply peaks in AIS transmissions.

Replacing Batteries

The mechanism for installing the batteries is the same regardless of which enclosure is provided. A plastic insert is vacuum-sealed to the full length of the inside of the battery chamber to prevent internal shorting.

To replace the batteries:

- Slowly unscrew the bottom endcap of the Petrel. Any batteries already installed are under spring pressure.
- Tip the old batteries out of the enclosure. Make sure to dispose of them appropriately.
- Slide the first battery into the column, ensuring that the positive (+) terminal faces the head of the Petrel (or SubConn connector if a Remote Head).
- Add the remaining batteries in the same orientation.
- Restore the endcap to its place on the device, taking care to inspect the O-ring first.

Batteries should be removed if the device is entering storage.

DO NOT MIX BATTERY TYPES

O-Rings

The Petrel has permanent O-rings installed in the head that are not meant to be replaced. The head of the Petrel proper is torqued at the factory to prevent accidental opening.

The O-ring of the battery pack endcap is user-replaceable and should be visually inspected to make sure it is properly seated in its groove. It should also be inspected for visible damage or debris.

If the O-rings pass visual inspection and have been deployed for two months or less, they do not need to be replaced.

If the O-rings fail visual inspection or have been deployed for longer than 2 months, they should be replaced prior to re-deploying the Petrel.



All Petrels employ O-ring size **2-031/N70** in their endcaps.

Replacing O-Rings

To replace the O-Ring:

- Remove the old O-ring, and clean all dirt away from the threads and grooves where it was seated using a lint-free cloth, cleaning alcohol, and a soft-brush.
- Apply a thin layer of seal lubricant (**MOLYKOTE 111** from Dow Corning) to the new O-ring.
- Slide the new O-ring down over the threads of the endcap and into the O-ring groove.

It is very important to be aware of where the O-ring is sitting on the end-cap. If the O-ring is not sitting perfectly in its groove, there will not be a perfect seal; this could cause fatal damage to the unit.

Connector Grease (Remote Head)

The connector for every Petrel Remote Head and battery pack manufactured at Xeos is filled with grease to protect the conductive material. If replenishing this grease, Xeos recommends **MOLYKOTE 44 Medium**.

Electrical Specifications

Power Supply	
Supply Range	7 – 16 VDC
Battery Supply (Xeos Battery Pack)	Short Pack - Qty 3 Saft LSH-20, D-Cell, 10.8V Nominal Long Pack - Qty 7 Energizer Industrial LR-20, D-Cell, 10.5V Nominal
Battery Capacity	Short Pack – 13 Ah Long Pack – 17.5 Ah

Current Consumption (12VDC)	
GPS Search Mode	25mA
AIS Operation Mode	34mA
AIS Transmission (~40ms duration)	700mA
Bluetooth Mode	10mA
Underwater Mode	200µA
Device Off	200µA

Batteries should be removed if the device is entering storage.

Electronics	
Digital Controller	Xeos Petrel
GNSS Receiver	Xeos Technologies 48 channel GNSS (SiRFStarV)
Antenna	Xeos proprietary antenna, designed to withstand high pressure environments

Maintenance Specifications

O-rings	
O-ring Size	2-031/N70
O-ring Lubricant	MOLYKOTE 111

SubConn	
Connector Lubricant	MOLYKOTE 44 Medium

Connector Pinout

Petrel Remote Head

Pin Number	Name
1	N/C
2	N/C
3	N/C
4	+V Battery
5	N/C
6	Ground

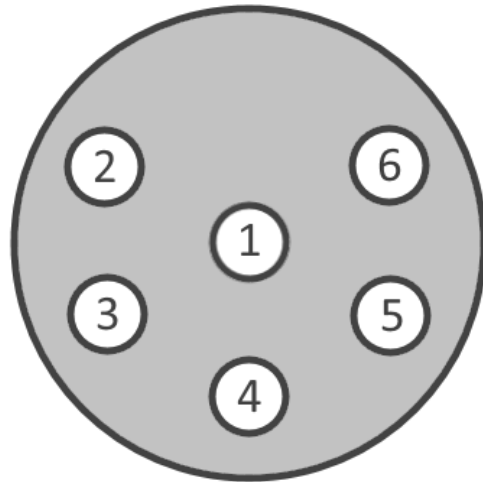

Connector: MCBH-6F-TI, External View

Battery Pack

Pin Number	Name
1	N/C
2	N/C
3	N/C
4	+V Battery
5	N/C
6	Ground

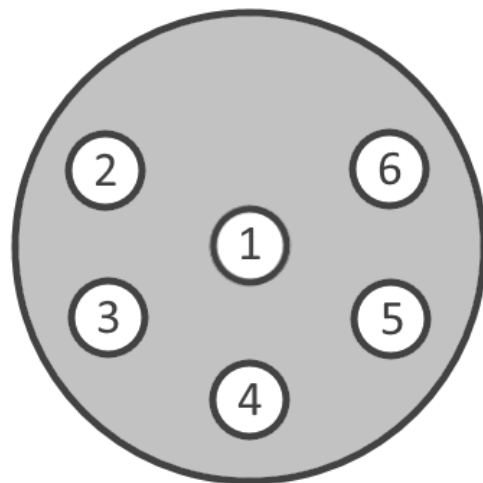

Connector: MCBH-6F-TI, External View

Mechanical Drawing

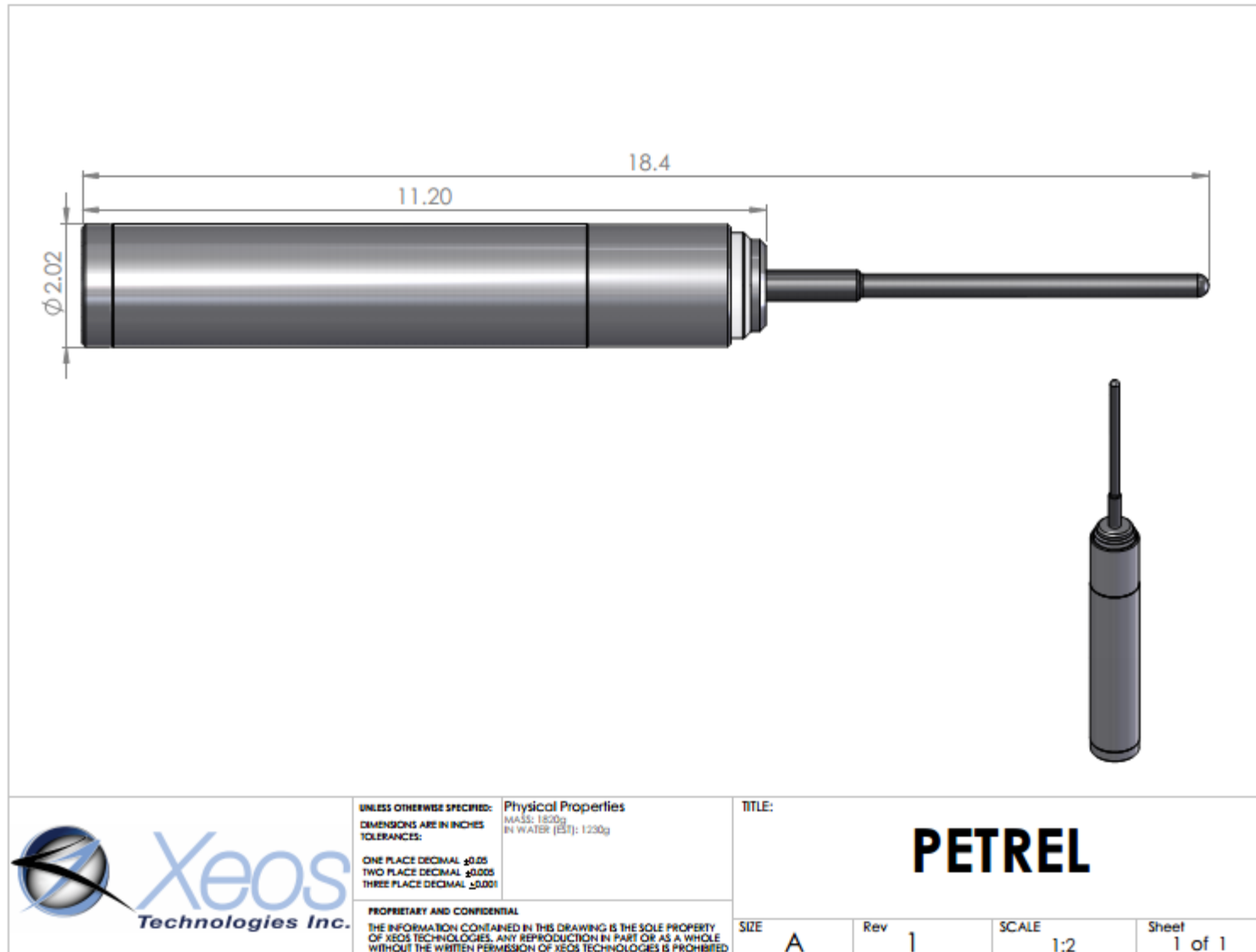

Warranty, Support and Limited Liability

Xeos Technologies Inc. warrants the Petrel to be free of defects in material or manufacturing for a period of one year following delivery. Liability is limited to repair or replacement of the defective part and will be done free of charge.

LIMITED WARRANTY: Xeos Technologies Inc. warrants that the product will perform substantially in accordance with the accompanying written materials for a period of one year from the date of receipt.

CUSTOMER REMEDIES: Xeos Technologies Inc. entire liability and your exclusive remedy shall be at Xeos Technologies Inc. option, either (a) return of the price paid or (b) repair or replacement of the product that does not meet Xeos Technologies Inc. Limited Warranty and that is returned to Xeos Technologies Inc. with a copy of your receipt. This Limited Warranty is void if failure of the product has resulted from accident, abuse, or misapplication. Any replacement product will be warranted for the remainder of the original warranty period or ninety (90) days, whichever is longer.

NO OTHER WARRANTIES: Xeos Technologies Inc. disclaims all other warranties, either express or implied, including but not limited to implied warranties of merchantability and fitness for a particular purpose, with respect to the product or the accompanying written materials. This limited warranty gives you specific legal rights. You may have others, which vary from state to state.

NO LIABILITY FOR CONSEQUENTIAL DAMAGES: In no event shall Xeos Technologies Inc. or its suppliers be liable for any damages whatsoever (including, without limitation, damages for loss of equipment, for loss of business profits, business interruption, loss of business information, or other pecuniary loss) arising out of the use of or inability to use this Xeos Technologies Inc. product, even if Xeos Technologies Inc. has been advised of the possibility of such damages.